

AYENSO POMPA



AY-8-S

PARÇA LİSTESİ

	KOD	PARÇA ADI	MALZEME
1	AY-8-S-M	Motor	1,1 kw
2	AY-8-S-AK	Arka Kapak	PP
3	AY-8-S-M	Mil	AISI 304-316
4	S2	Salmastra	S.Karbür-S.Karbür-Viton S.Karbür-S.Karbür-EPDM
5	AY-8-S-AD	Ara Disk	PP/ PVC/ PVDF/ PE
6	AY-8-S-O	O-Ring	Viton/ EPDM
7	AY-8-S-C	Çark	PP/ PVC/ PVDF/ PE
8	AY-8-S-S	Salyangoz	PP/ PVC/ PVDF/ PE
9		Civata+Pul+Somun	AISI 304

TEKNİK ÖZELLİKLER

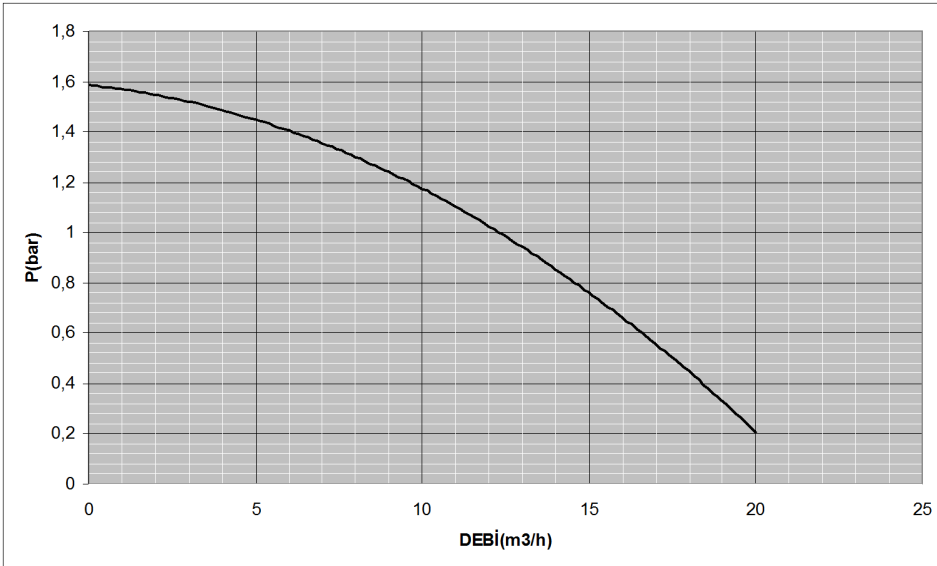
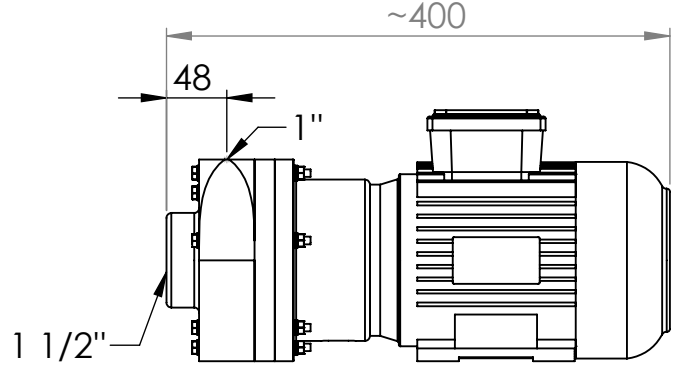
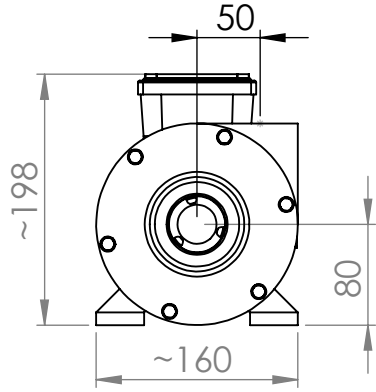

Max. Basınç	1,6 bar
Max. Debi	20 m³/h
Toplam Ağırlık	13 kg
Güç	1,1 kW
Voltaj	400 V
Frekans	50 Hz.
Faz	3
Devir	2800 RPM
Koruma Sınıfı	IP55