

AYENSO POMPA



AY-6-M

PARÇA LİSTESİ

	KOD	PARÇA ADI	MALZEME
1	AY-6-M-M	Motor	0,25 kw
2	AY-6-M-AK	Arka Kapak	PP
3	AY-6-M-MD	Manyetik Disk	Çelik
4	AY-6-M-AD	Ara Disk	PP/ PVC/ PVDF/ PE
5	AY-6-M-P	Pul	Seramik
6	AY-6-M-Ş	Şaft	Seramik
7	AY-6-M-O	O-ring	Viton/ EPDM
8	AY-6-M-C	Çark	PP/ PVC/ PVDF/ PE
9	AY-6-M-S	Salyangoz	PP/ PVC/ PVDF/ PE
10		Civata+pul+somun	AISI 304

TEKNİK ÖZELLİKLER

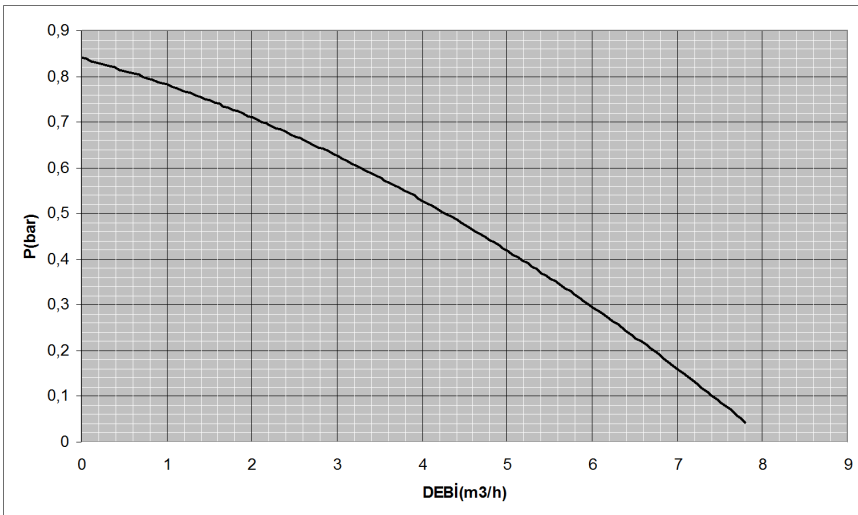
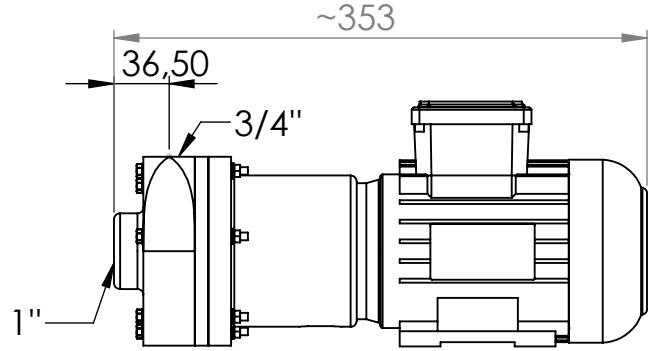
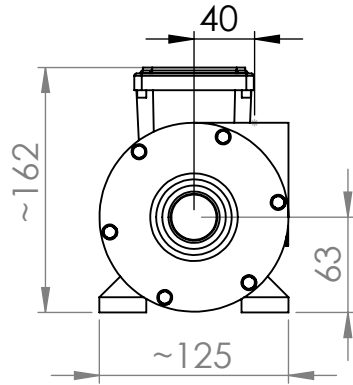
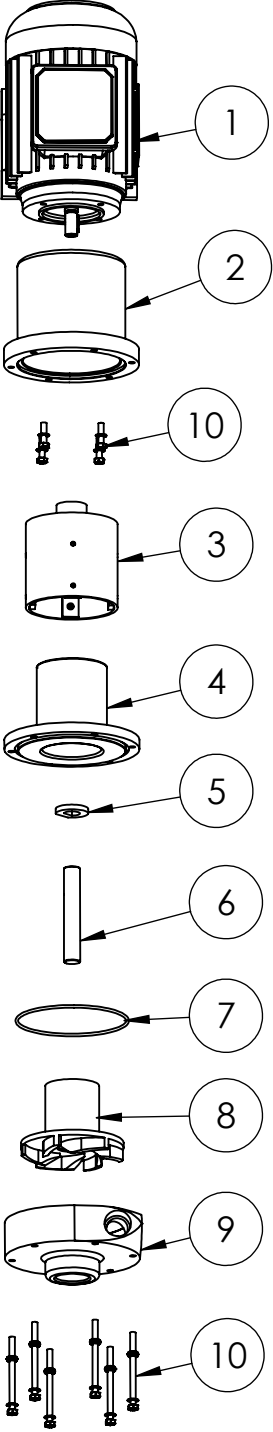

Max. Basınç	0,9 bar
Max. Debi	8 m³/h
Toplam Ağırlık	6,5 kg
Güç	0,25 kw
Voltaj	400 V
Frekans	50 Hz.
Faz	3
Devir	2800 RPM
Koruma Sınıfı	IP55